

Product Shape

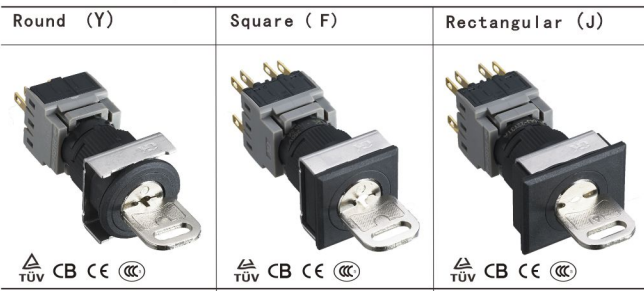

Outline Dimensional drawing (mm)

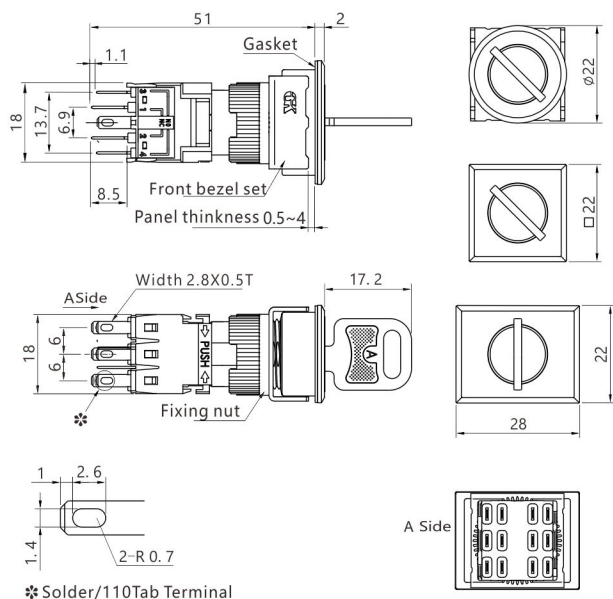

* Solder/110Tab Terminal

Key removable position

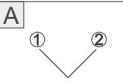
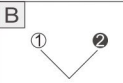
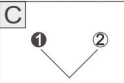
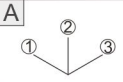
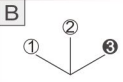
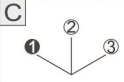
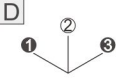
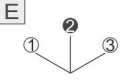
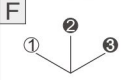
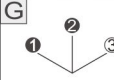













Position Type	Code	Note: ①, ②, ③ Key removable position.
2-Position	A	
	B	
	C	
3-Position	A	
	B	
	C	
	D	
	E	
	F	
	G	

Model Specifications

AF16 4 YB-11 Y2 T A

Series: AF16
Protection Degree: 4
Head Shape: YB
Key removable Positions: 11
Operating Type: Y2
Position Pattern: T
Contact Arrangement: A

(Note1) Protection Degree 4=IP40 5=IP65

Style	Operator position	Contact	Part No.
Round (YB)	90°-2	Maintained 	SPDT AF16□YB-11Y2T▲
			DPDT AF16□YB-11Y2T▲
			3PDT AF16□YB-11Y2T▲
		Spring return 	SPDT AF16□YB-11Y2▲
			DPDT AF16□YB-11Y2▲
			3PDT AF16□YB-11Y2▲
	45°-3	Maintained 	DPDT AF16□YB-22Y3T▲
			3PDT AF16□YB-33Y3T▲
			3PDT AF16□YB-33Y3▲
		Spring-return two-way 	DPDT AF16□YB-22Y3▲
			3PDT AF16□YB-33Y3TR▲
			3PDT AF16□YB-22Y3TR▲
Square (FB)	90°-2	Maintained 	DPDT AF16□FB-11Y2T▲
			DPDT AF16□FB-11Y2T▲
			3PDT AF16□FB-11Y2T▲
	Spring return 	SPDT AF16□FB-11Y2▲	
		DPDT AF16□FB-11Y2▲	
		3PDT AF16□FB-11Y2▲	
45°-3	Maintained 	DPDT AF16□FB-22Y3T▲	
		3PDT AF16□FB-33Y3T▲	
		3PDT AF16□FB-33Y3▲	
	Spring-return two-way 	DPDT AF16□FB-22Y3▲	
		3PDT AF16□FB-33Y3▲	
		3PDT AF16□FB-33Y3▲	
Rectangular (JB)	90°-2	Maintained 	DPDT AF16□JB-11Y2T▲
			DPDT AF16□JB-11Y2T▲
			3PDT AF16□JB-11Y2T▲
	Spring return 	SPDT AF16□JB-11Y2▲	
		DPDT AF16□JB-11Y2▲	
		3PDT AF16□JB-11Y2▲	
45°-3	Maintained 	DPDT AF16□JB-22Y3T▲	
		3PDT AF16□JB-33Y3T▲	
		3PDT AF16□JB-33Y3▲	
	Spring-return two-way 	DPDT AF16□JB-22Y3▲	
		3PDT AF16□JB-33Y3▲	
		3PDT AF16□JB-33Y3▲	
Left return right Maintained 	DPDT AF16□JB-22Y3TR▲		
	3PDT AF16□JB-22Y3TR▲		
	3PDT AF16□JB-22Y3TR▲		
Left Maintained right return 	DPDT AF16□JB-22Y3TL▲		
	3PDT AF16□JB-33Y3TL▲		
	3PDT AF16□JB-33Y3TL▲		