

Product Shape

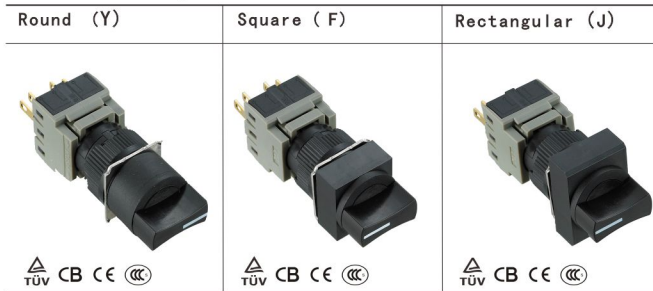

Outline Dimensional drawing (mm)

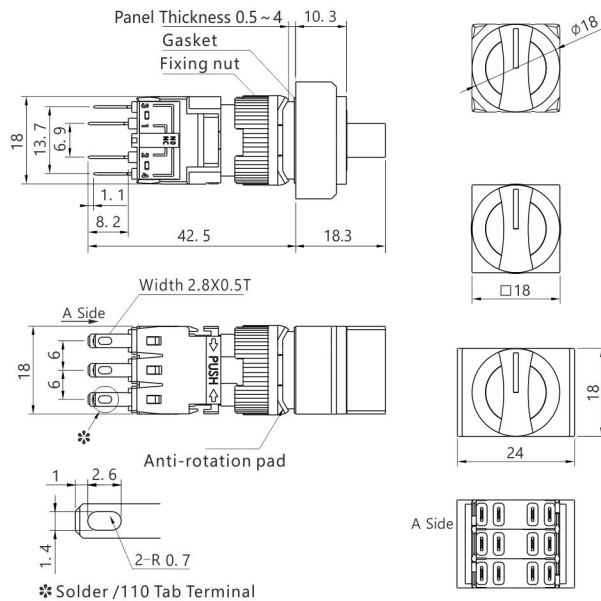





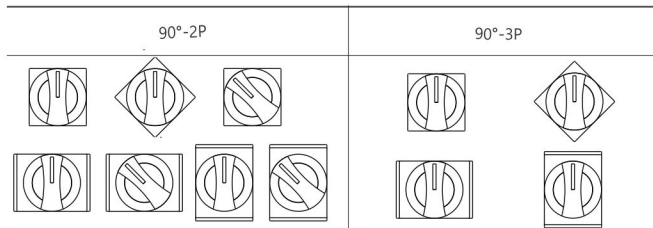



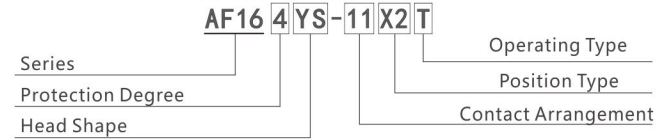







Handle Position

- Selector Switch & Key Switch



Model Specifications



| Style  | Operator position   | contact   | Part No.   |                    |
|--|---|---|--|--------------------|
| Round (YS)   | 90°-2   | Maintained               | SPDT AF16□YS-11X2T   |                    |
|  |   |   | DPDT AF16□YS-11X2T   |                    |
|  |   |   | 3PDT AF16□YS-11X2T   |                    |
|  |   | Spring return            | SPDT AF16□YS-11X2  |                    |
|  |   |   | DPDT AF16□YS-11X2  |                    |
|  |   |   | 3PDT AF16□YS-11X2  |                    |
|  | 45°-3   | Maintained               | DPDT AF16□YS-22X3T   |                    |
|  |   |   | 3PDT AF16□YS-33X3T   |                    |
|  |   |   | DPDT AF16□YS-22X3  |                    |
|  |   | Spring-return two-way    | 3PDT AF16□YS-33X3  |                    |
|  |   |   | DPDT AF16□YS-22X3TR  |                    |
|  |   |   | 3PDT AF16□YS-22X3TR  |                    |
| Left return right Maintained    |   | DPDT AF16□YS-22X3TL   |  |                    |
|  |   | 3PDT AF16□YS-33X3TL   |  |                    |
|  |   | DPDT AF16□YS-22X3TL   |  |                    |
| Square (FS)  |   | 90°-2   | Maintained  | SPDT AF16□FS-11X2T |
|  |   |   |  | DPDT AF16□FS-11X2T |
|  |   |   |  | 3PDT AF16□FS-11X2T |
|  | Spring return  |   | SPDT AF16□FS-11X2  |                    |
|  |   |   | DPDT AF16□FS-11X2  |                    |
|  |   |   | 3PDT AF16□FS-11X2  |                    |
|  | 45°-3   | Maintained               | DPDT AF16□FS-22X3T   |                    |
|  |   |   | 3PDT AF16□FS-33X3T   |                    |
|  |   |   | DPDT AF16□FS-22X3  |                    |
|  |   | Spring-return two-way    | 3PDT AF16□FS-33X3  |                    |
|  |   |   | DPDT AF16□FS-22X3TR  |                    |
|  |   |   | 3PDT AF16□FS-22X3TR  |                    |
| Left return right Maintained   | DPDT AF16□FS-22X3TL   |   |  |                    |
|  | 3PDT AF16□FS-33X3TL   |   |  |                    |
|  | DPDT AF16□FS-22X3TL   |   |  |                    |
| Rectangular (JS)   | 90°-2   | Maintained             | SPDT AF16□JS-11X2T   |                    |
|  |   |   | DPDT AF16□JS-11X2T   |                    |
|  |   |   | 3PDT AF16□JS-11X2T   |                    |
|  |   | Spring return          | SPDT AF16□JS-11X2  |                    |
|  |   |   | DPDT AF16□JS-11X2  |                    |
|  |   |   | 3PDT AF16□JS-11X2  |                    |
|  | 45°-3   | Maintained             | DPDT AF16□JS-22X3T   |                    |
|  |   |   | 3PDT AF16□JS-33X3T   |                    |
|  |   |   | DPDT AF16□JS-22X3  |                    |
|  |   | Spring-return two-way  | 3PDT AF16□JS-33X3  |                    |
|  |   |   | DPDT AF16□JS-22X3TR  |                    |
|  |   |   | 3PDT AF16□JS-22X3TR  |                    |
| Left return right Maintained  | DPDT AF16□JS-22X3TL   |   |  |                    |
|  | 3PDT AF16□JS-33X3TL   |   |  |                    |
|  | DPDT AF16□JS-22X3TL   |   |  |                    |

1. For part numbers specify:  
-Protection degree in place of □: 4(IP54); 5(IP65)