

Product Shape

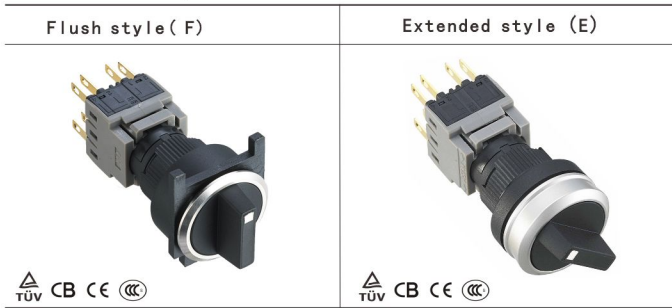

Outline Dimensional drawing (mm)

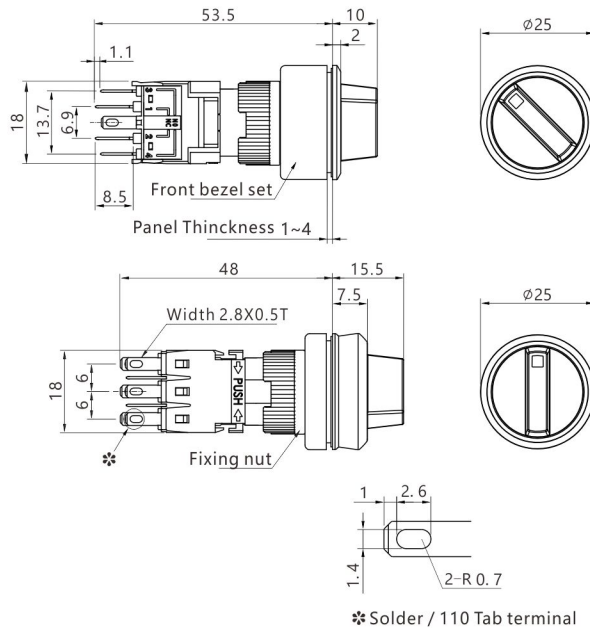





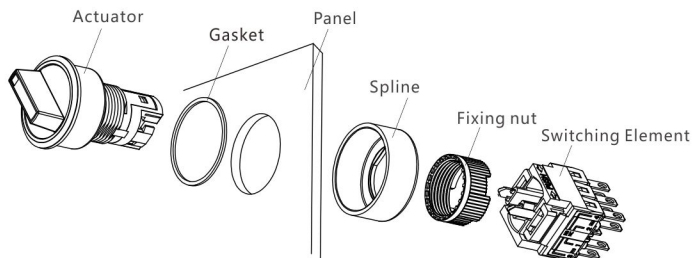



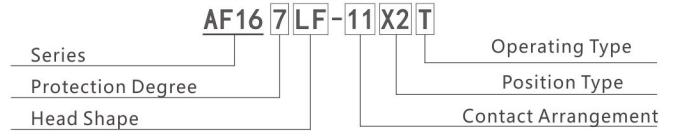

Installation Method

- Selector Switch & Key Switch



Model Specifications



Style	Operator position	contact	Part No.
Flush (LF)	90°-2	Maintained 	SPDT AF16□LF-11X2T DPDT AF16□LF-11X2T 3PDT AF16□LF-11X2T
		Spring return 	SPDT AF16□LF-11X2 DPDT AF16□LF-11X2 3PDT AF16□LF-11X2
			45°-3
	Spring-return two-way 	3PDT AF16□LF-33X3	
	Left return right Maintained 	DPDT AF16□LF-22X3TR 3PDT AF16□LF-22X3TR	
	Left Maintained right return 	DPDT AF16□LF-22X3TL 3PDT AF16□LF-33X3TL	
Extend (LE)	90°-2	Maintained 	SPDT AF16□LE-11X2T DPDT AF16□LE-11X2T 3PDT AF16□LE-11X2T
		Spring return 	SPDT AF16□LE-11X2 DPDT AF16□LE-11X2 3PDT AF16□LE-11X2
			45°-3
	Spring-return two-way 	3PDT AF16□LE-33X3	
	Left return right Maintained 	DPDT AF16□LE-22X3TR 3PDT AF16□LE-22X3TR	
	Left Maintained right return 	DPDT AF16□LE-22X3TL 3PDT AF16□LE-33X3TL	

Operator Position

- 2-Position & 3-Position Selector Switch

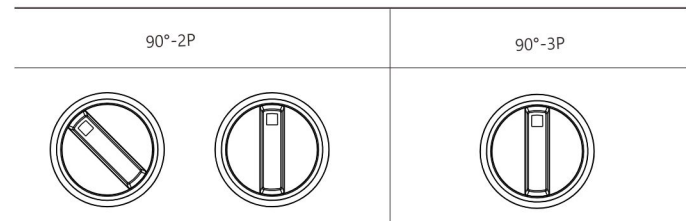

Note: other installation methods of the head can be operated conveniently according to the actual operation