

Product Shape

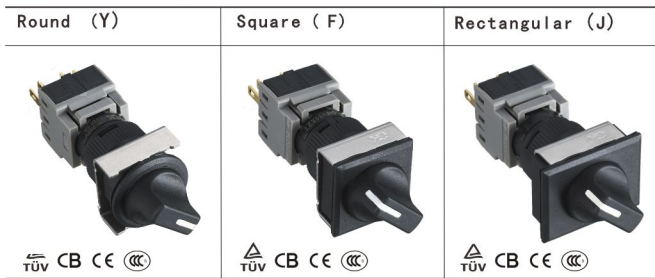

Outline Dimensional drawing (mm)

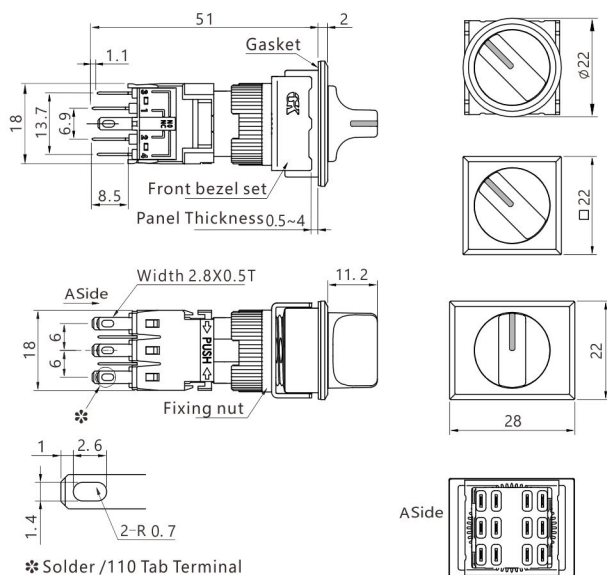

* Solder /110 Tab Terminal

Handle Position

- Selector Switch & Key Switch

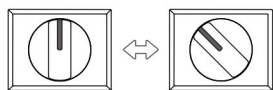



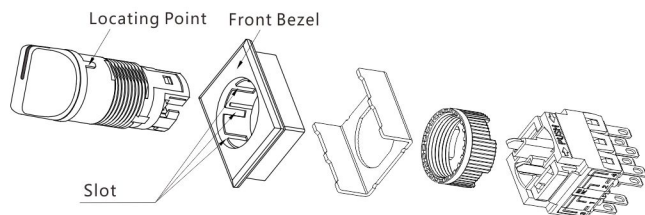



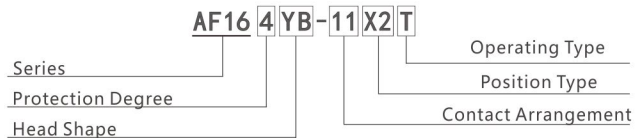







• 由于头部框架与旋钮（钥匙）部为分离式结构，因此可以45°角的间距任意变换操作角度的位置（仅限方形和矩形）。



Model Specifications



(Note1) Protection Degree 4=IP54 5=IP65

Style	Operator position	contact	Part No.
Round (YS)	90°-2	Maintained 	SPDT AF16□YB-11X2T
		DPDT AF16□YB-11X2T	
		3PDT AF16□YB-11X2T	
	Spring return 	SPDT AF16□YB-11X2	
		DPDT AF16□YB-11X2	
		3PDT AF16□YB-11X2	
45°-3	Maintained 	DPDT AF16□YB-22X3T	
		3PDT AF16□YB-33X3T	
		DPDT AF16□YB-22X3	
	Spring-return two-way 	3PDT AF16□YB-33X3	
		DPDT AF16□YB-22X3TR	
		3PDT AF16□YB-22X3TR	
Left return right Maintained 	DPDT AF16□YB-22X3TL		
	3PDT AF16□YB-22X3TL		
	DPDT AF16□YB-33X3TL		
Square (FS)	90°-2	Maintained 	SPDT AF16□FB-11X2T
		DPDT AF16□FB-11X2T	
		3PDT AF16□FB-11X2T	
	Spring return 	SPDT AF16□FB-11X2	
		DPDT AF16□FB-11X2	
		3PDT AF16□FB-11X2	
45°-3	Maintained 	DPDT AF16□FB-22X3T	
		3PDT AF16□FB-33X3T	
		DPDT AF16□FB-22X3	
	Spring-return two-way 	3PDT AF16□FB-33X3	
		DPDT AF16□FB-22X3TR	
		3PDT AF16□FB-22X3TR	
Left return right Maintained 	DPDT AF16□FB-22X3TL		
	3PDT AF16□FB-22X3TL		
	DPDT AF16□FB-33X3TL		
Rectangular (JS)	90°-2	Maintained 	SPDT AF16□JB-11X2T
		DPDT AF16□JB-11X2T	
		3PDT AF16□JB-11X2T	
	Spring return 	SPDT AF16□JB-11X2	
		DPDT AF16□JB-11X2	
		3PDT AF16□JB-11X2	
45°-3	Maintained 	DPDT AF16□JB-22X3T	
		3PDT AF16□JB-33X3T	
		DPDT AF16□JB-22X3	
	Spring-return two-way 	3PDT AF16□JB-33X3	
		DPDT AF16□JB-22X3TR	
		3PDT AF16□JB-22X3TR	
Left return right Maintained 	3PDT AF16□JB-22X3TR		
	DPDT AF16□JB-22X3TL		
	DPDT AF16□JB-33X3TL		